

liniLED[®] MONO

FLEXIBLE LINEAR LED MODULE



MONO COLOR SPECIFICATION



Specification grade waterproof flexible linear LED light strip allowing an endless range of applications for direct or indirect view, as functional or decorative lighting for coves, backlighting, stairs, niches, signs, marine applications. Very low energy (1W ft) with very high output, with no UV or IR. liniLED[®] can be applied both indoors and outdoors. Co-extruded with built in reflectors the highly flexible UV stabilized, optically clear PVC seals LEDs for permanent protection against adverse environments and handling. Rapid mounting in long runs with "Solder free" push-fit connections. LiniLED SIDE enables horizontal bends to be made for curves or columns.

Specially designed circuitry guarantees optimal controlled output by modifying and stabilizing input every section of seven LEDs, ensuring color stability and exceptionally cool operation for longest LED life. Pulse Width Modulation dimmable for smooth dimming and extended LED life (10% dimming is estimated to double the LED life). Plug and Play system design simplifies installation and specification. Manufactured in the EU/ RoHS.

White Warm White Blue Red Amber Green



liniLED TOP

Extruded reflector with optically clear encapsulation of LEDs.
Dimensions: 1/4" h x 1/2" w
Curving Direction:

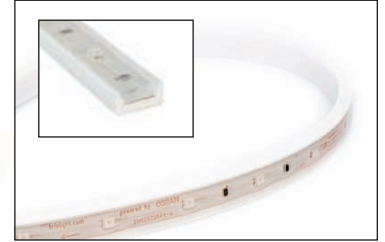

liniLED SIDE

Extruded reflector with optically clear encapsulation of LEDs.
Dimensions: 1/2" h x 1/2" w
Curving Direction:

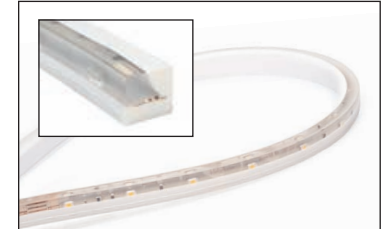

liniLED: Extruded reflector with optically clear encapsulation of LEDs.

liniLED MONO COLOR - SPECIFICATIONS

LED	SMD OSRAM POWER TopLED
Number of LEDs	11 per ft/35 per meter, 164ft long (50m) reels
LED Color	Amber / Red / Green / Blue / White, 6.5k / Warm White, 3k. CRI 80
Beam / Flux	120°; White - 38.83 lumen/ft Warm White - 33.25 lumen/ft
Dimensions	TOP: H 0.25" x W 0.50" (H6xW12mm) SIDE: H 0.50" x W 0.50" (H12xW12mm)
Length (m)	Up to 66ft (20m) continuous runs, field cuttable every 8" (20cm). 164ft reel
Bend Radius	1.2" (30mm)
Indoor or Outdoor (IP68)	Wet location (protected connectors)
Watts and Voltage	24VDC; 1 W/ft. (3.3W/m); ETL / CE
Material	UV/IR protected PVC.
Dimmable	Pulse Width Modulation, maintains consistent lumen output and color
Life	50,000 hours white; Up to 100,000 hours for colors (mfc.data at 25°C) LM-79, 5 years limited warranty
24VDC	Select appropriate wattage power supplies, according to run length and number of runs
Accessories	Dimming controllers; adhesive backed polycarbonate mounting channel; mounting saddles; power cord sets; extension cords; aluminum extrusions and diffusers

MOUNTING & DIMENSIONS

Polycarbonate Mounting Channel, self-adhesive backed, grips liniLED tightly for straight runs in minimum space. Apply to coves, surfaces or inside liniLED aluminum extrusions



Mounting saddle, screws to structure.

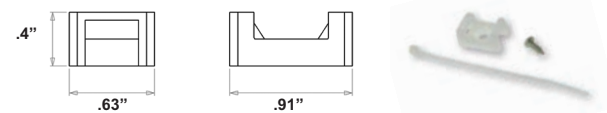

Power Connector Set

push fit connection to 1/4" stripped end of liniLED and secured with a press in staple.

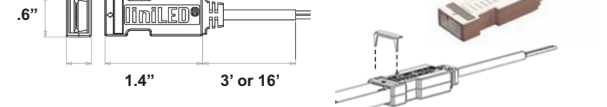

IES DISTRIBUTION CURVE

IES:- LF07T-W3F-865

Luminaire: LiniLED White; 6500k / CRI 80
 Luminaire Luminous Flux: 25.47 lm
 Luminaire Wattage: 0.66 W
 100 CIE flux code: 48 80 97 100 100

IES:- LF07T-W3F-830

Luminaire: Warm White; 3000k / CRI 80
 Luminaire Luminous Flux: 21.81 lm
 Luminaire Wattage: 0.66 W
 100 CIE flux code: 48 80 97 100 100

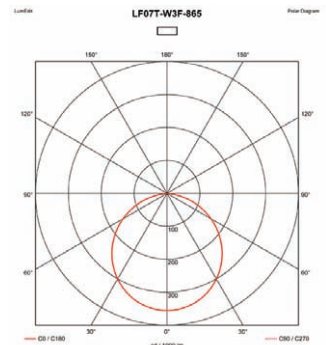

TECHNICAL DATA

Description	Max Run Length	No. of LEDs (per ft)	V/DC	Current (A)	Color	CRI	Lumens (ft)	CD/ft	W/ft	Bin
RGB	8" - 33ft	11	24	350mA	RGB		37	13.2	1.5	
Amber	8" - 66ft	11	24	350mA	587nm		4.45	1.6	.5	
Red	8" - 66ft	11	24	350mA	617nm		11.11	4	1	
Green	8" - 66ft	11	24	350mA	525nm		33.9	12.1	.80	
Blue	8" - 66ft	11	24	350mA	469nm		3.99	1.4	.30	
Cool White	8" - 66ft	11	24	350mA	6500K	80	38.83	13.9	.70	Fine
Warm White	8" - 66ft	11	24	350mA	3000K	80	33.25	11.9	1	Fine

ORDERING liniLED

1. PART#		2. COLOR		3. FEET	4. LOCATION		5. PRIMARY VOLTS	
LIN								
TOP	SIDE	Amber	A	Enter Feet	Interior	I	120	
Amber 011603	Amber 011761	Red	R		Exterior	E	277	
Red 011604	Red 011762	Green	G				240	
Green 011605	Green 011763	Blue	B				347	
Blue 011606	Blue 011764	White 3000k	W3					
CW 011607	CW 011765	White 6500k	W6					
WW 011601	WW 011766							

Specify additional components if known, or request quotation.

ORDER POWER CORDS TO MATCH NO. OF RUNS:

liniLED Top	QTY	liniLED Side	QTY
3'3" Long 011786	<input type="checkbox"/>	3'3" Long 011767	<input type="checkbox"/>
16' Long 011788	<input type="checkbox"/>	16' Long 011768	<input type="checkbox"/>

Wet Location Connector Cover, IP68:	QTY
Connector Splice Box	011533 <input type="checkbox"/>

MOUNTING:

Top and Side liniLED:	QTY
Poly/Carb Channel - self adhesive, 3ft L.	011369 <input type="checkbox"/>
Screw on Saddle (25 pack)	011375 <input type="checkbox"/>

POWER SUPPLIES:

IP67, Class II, UL, Constant voltage.

Watts		120V	QTY	277V	QTY
20W/18ft	Power supply 24V/DC	011310	<input type="checkbox"/>	-	
30W/27ft	Power supply 24V/DC	011307	<input type="checkbox"/>	011307	<input type="checkbox"/>
60W/54ft	Power supply 24V/DC	011315	<input type="checkbox"/>	011315	<input type="checkbox"/>
100W/90ft	Power supply 24V/DC	011321	<input type="checkbox"/>	011321	<input type="checkbox"/>
150W/135ft	Power supply 24V/DC	011327	<input type="checkbox"/>	011327	<input type="checkbox"/>
240W/216ft	Power supply 24V/DC	011331	<input type="checkbox"/>	011331	<input type="checkbox"/>

Dimmable Power Supplies:

Watts		120V	QTY	277V	QTY
30W/27ft	Power supply 24V/DC	011308	<input type="checkbox"/>	-	
60W/54ft	Power supply 24V/DC	011314	<input type="checkbox"/>	-	
100W/90ft	Power supply 24V/DC	011322	<input type="checkbox"/>	011322	<input type="checkbox"/>
150W/135ft	Power supply 24V/DC	011328	<input type="checkbox"/>	011328	<input type="checkbox"/>
240W/216ft	Power supply 24V/DC	011332	<input type="checkbox"/>	011332	<input type="checkbox"/>

Indoor Power Supplies:

		120V	QTY	277V	QTY
320W/288ft	Power supply 24V/DC	011335	<input type="checkbox"/>	-	
500W/450ft	Power supply 24V/DC	011339	<input type="checkbox"/>	-	

For a full list of components and accessories see Accessories page.

CONNECTION DIAGRAM MONO COLOR

Cable gages from remote power supply.
 18 AWG up to 10'
 16 AWG up to 20'
 14 AWG up to 40'
 12 AWG up to 60'
 10 AWG up to 100'

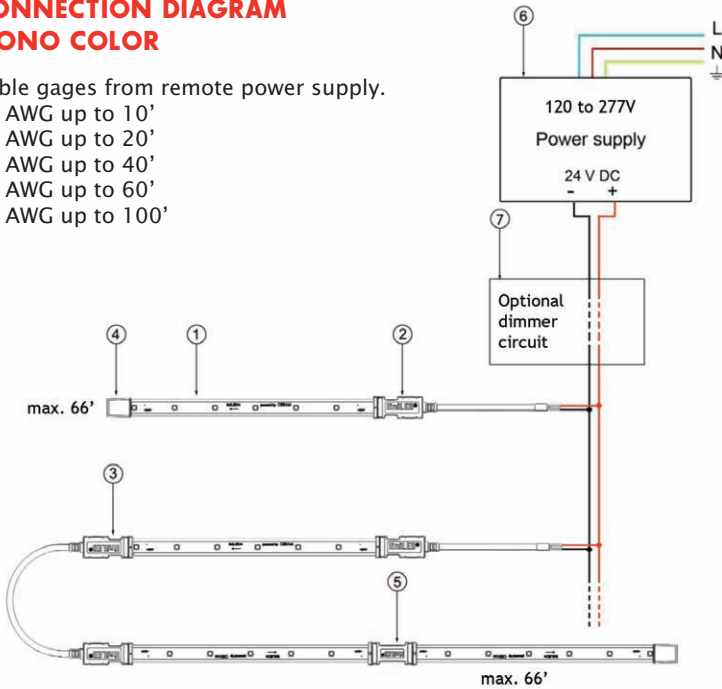

INSTALLATION

Installing:

liniLED is easy to specify and simple to install. It can be cut every 8" and continuous lengths up to 66ft for single color LEDs can be run from the power supply.

Power Supplies - 24V.DC Constant Voltage:

Check the Power Supplies Guide and select the Power Supplies corresponding to the run lengths. Select the Controller/s or Dimmer/s (see Dimming Control page).

Power Cords with Connector:

Select the power Connector cord sets, either 3'3" or 16'3" long to match the number of runs. Bends can be made with 10" extension leads. Interconnection can be made with Inline connectors. Waterproof connections require the connectors to be protected with a liniLED splice box supplied with a resin glue which protects connections to IP68.

Mounting:

Adhesive backed polycarbonate mounting channel which can be cut to length, enable quick mounting on smooth surfaces, or select screw on mounting saddles.

Extruded aluminum housings are available for surface or recessed mounting, creating coves, step extrusions for direct view or indirect illumination and under cabinet/wall mounting extrusions can be specified.

liniLED[®] MONO COLOR DIMMING CONTROL

liniLED is dimmable using Pulse Width Modulation (PWM).





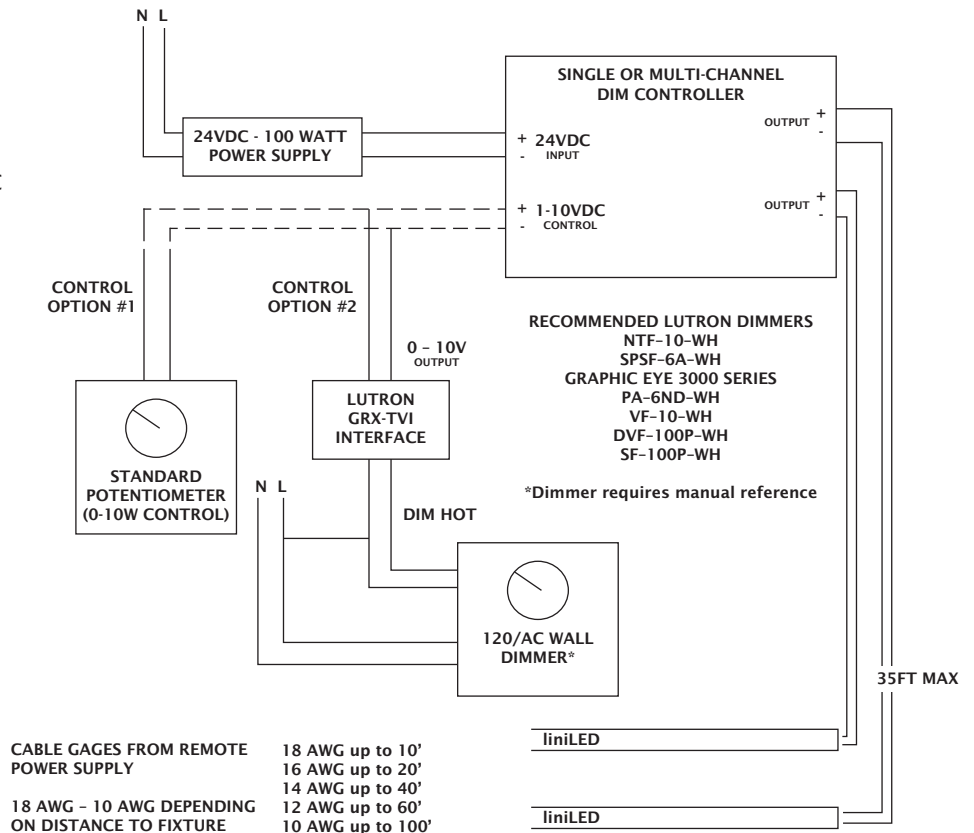



- Dim with simple 0-10V dimmers or DMX/RDM dimmer controls.
- Dim only on the DC side.
- Magnetic power supplies and dimming on the AC side will not work.

Typical Dimming Control System Layout





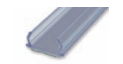





CORD SETS AND CONNECTORS



LiniLED TOP Connectors

-  **011745** Power Cord Set for liniLED, **RGB 3'3"**
-  **011746** Power Cord Set for liniLED, **RGB 16'3"**
-  **011786** Power Cord for liniLED, **Mono Color 3'3"**
-  **011788** Power Cord for liniLED, **Mono Color 16'3"**
-  **011503** End cap liniLED
-  **011747** Inter-connector liniLED, **RGB**
-  **011790** Inter-connector liniLED, **Mono Color**
-  **011748** Extension cord liniLED, **RGB 10"L**
-  **011792** Extension cord liniLED, **Mono Color 10"L**

LiniLED SIDE Connectors

-  **011771** Power Cord Set liniLED Side, **RGB 3'3"**
-  **011772** Power Cord Set liniLED Side, **RGB 16'3"**
-  **011767** Power Cord liniLED Side, **Mono Color 3'3"**
-  **011768** Power Cord liniLED Side, **Mono Color 16'3"**
-  **011504** End cap liniLED Side
-  **011773** Inter-connector liniLED Side, **RGB**
-  **011769** Inter-connector liniLED Side, **Mono Color**
-  **011774** Extension cord liniLED Side, **RGB 10"L**
-  **011770** Extension cord liniLED Side, **Mono Color 10"L**

MOUNTING





-  **011369** Adhesive backed Channel - Cuttable 39"L
-  **011375** Mounting Saddle - screw on

WATERPROOF CONNECTIONS





-  **011533** IP68 Submersible Connector Splice Box

LiniLED EXTRUSIONS AND PROFILES

3/4" (20mm) Linear

-  **010982** Linear extrusion 3/4" white
-  **010959** Acrylic Lens 3/4" frosted
-  **010965** Acrylic Lens 3/4" clear *(pictured to the left)*
-  **010969** End cap 3/4"
-  **010977** Mounting clip 3/4"



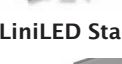

1 1/2" (40mm) Linear

-  **010985** Linear extrusion 1 1/2" white
-  **010961** Acrylic 1 1/2" frosted *(pictured to the left)*
-  **010967** Acrylic 1 1/2" clear
-  **010971** End cap 1 1/2"
-  **010979** Mounting clip 1 1/2"





LiniLED Wall/Floor Profiles

-  **011593** Wall/floor extrusion, silver
-  **011595** Wall/floor extrusion, black

LiniLED Stair Profiles







-  **011565** Stair extrusion, direct view, silver
-  **011567** Stair extrusion, direct view, black
-  **011836** Stair extrusion, indirect, silver
-  **011837** Stair extrusion, indirect, black

Cove Extrusion





-  **012809** Cove extrusion indirect, white
-  **011591** PC Cover for cove extrusion indirect, transparent
-  **011571** End cap left for cove extrusion
-  **011573** End cap right for cove extrusion

LiniLED POWER AND CONTROLS

Power Supply Indoor/Outdoor

-  **011310** 20W. 24V/DC IP67 4.5x1.5x1in 90-264VAC
-  **011307** 30W. 24V/DC IP64 6x2x1in 90-295VAC
-  **011315** 60W. 24V/DC IP64 7x2.5x1.5in 90-295VAC
-  **011321** 100W. 24V/DC IP64 8x3x1.5in 90-295VAC
-  **011327** 150W. 24V/DC IP65/67 8x3x1.5in 90-295VAC
-  **011331** 240W. 24V/DC IP65/67 8x4x2in 90-295VAC

Dimmable Power Supply Indoor/Outdoor

-  **011308** 30W. 24V/DC IP64 6x2x1in 90-264VAC
-  **011314** 60W. 24V/DC IP64 7x2.5x1.5in 90-264VAC
-  **011322** 100W. 24V/DC IP67 9x3x1.5in 90-305VAC
-  **011328** 150W. 24V/DC IP67 9x3x1.5in 90-305VAC
-  **011332** 240W. 24V/DC IP67 8x4x2in 90-305VAC

(continued on the next page...)

liniLED[®] MONO

FLEXIBLE LINEAR LED MODULE



MONO COLOR PARTS & ACCESSORIES

LiniLED POWER AND CONTROLS (continued from previous page...)

Power Supply Indoor



- 011335 320W Power supply 24V/DC 8.5x4.5x2in 85-264VAC
- 011339 500W Power supply 24V/DC 7x5x4in 85-264VAC

Outdoor Enclosed Power Supplies



- 011850 120W. Power supply unit, IP67
- 011851 240W. Power supply unit, IP67
- 011852 480W. Power supply unit, IP67

LiniLED RGB AND DIM CONTROLS

Power Supply Indoor



- 011455 Wall Dimmer built-in/on, 12-24VDC, white



- 011457 Digital PWM dimmer with push button control, 10A, 10~32VDC



- 011810 RGB Stand Alone PWM Controller, 24VDC 4,6A/110W



- 011150 RGB Basic Dim/Controller with DMX in/out



- 011466 LED Wall panel RGB, DMX control



- 011149 RGB PWM Dim Controller 12A - Programmable, including software



- 011147 RGB PWM Dimming Controller - Programmable, including software

Outdoor Enclosed RGB controls



- 011853 RGB Dim/Controller unit 120W
- 011854 RGB Dim/Controller unit 240W
- 011855 RGB Dim/Controller unit 480W

LiniLED IN-GROUND

Drive Over, Stainless steel



- 013100 liniLED PU, S/S In-ground, RGB 3'3"L
- 013110 liniLED PU, S/S In-ground, RGB 6'6"L
- 013104 liniLED PU, S/S In-ground, amber 3'3"L
- 013114 liniLED PU, S/S In-ground, amber 6'6"L
- 013103 liniLED PU, S/S In-ground, red 3'3"L
- 013113 liniLED PU, S/S In-ground, red 6'6"L
- 013105 liniLED PU, S/S In-ground, green 3'3"L
- 013115 liniLED PU, S/S In-ground, green 6'6"L
- 013106 liniLED PU, S/S In-ground, blue 3'3"L
- 013116 liniLED PU, S/S In-ground, blue 6'6"L
- 013101 liniLED PU, S/S In-ground, white 3'3"L
- 013111 liniLED PU, S/S In-ground, white 6'6"L
- 013102 liniLED PU, S/S In-ground, warm white 3'3"L
- 013112 liniLED PU, S/S In-ground, warm white 6'6"L



- 013120 PU Connector set 32'.6" liniLED PU, Mono Color
- 013121 PU Connector set 32'.6" liniLED PU, RGB

LiniLED DEMONSTRATION MATERIALS

LiniLED TOP - Accessories Are Included



- 011754 liniLED demo set, 3'.3", amber
- 011755 liniLED demo set, 3'.3", red
- 011758 liniLED demo set, 3'.3", white 6500K
- 011759 liniLED demo set, 3'.3", warm white 3000K
- 011749 liniLED RGB set, 3'.3"
- 011750 liniLED RGB set, 6'.6"

LiniLED SIDE - Accessories Are Included



- 011775 liniLED demo set, 3'.3", amber
- 011776 liniLED demo set, 3'.3", red
- 011777 liniLED demo set, 3'.3", blue
- 011778 liniLED demo set, 3'.3", green
- 011780 liniLED demo set, 3'.3", white 6500K
- 011782 liniLED demo set, 3'.3", warm white 3000K
- 011784 liniLED demo set, RGB

TRIMMING AND CONNECTING

